

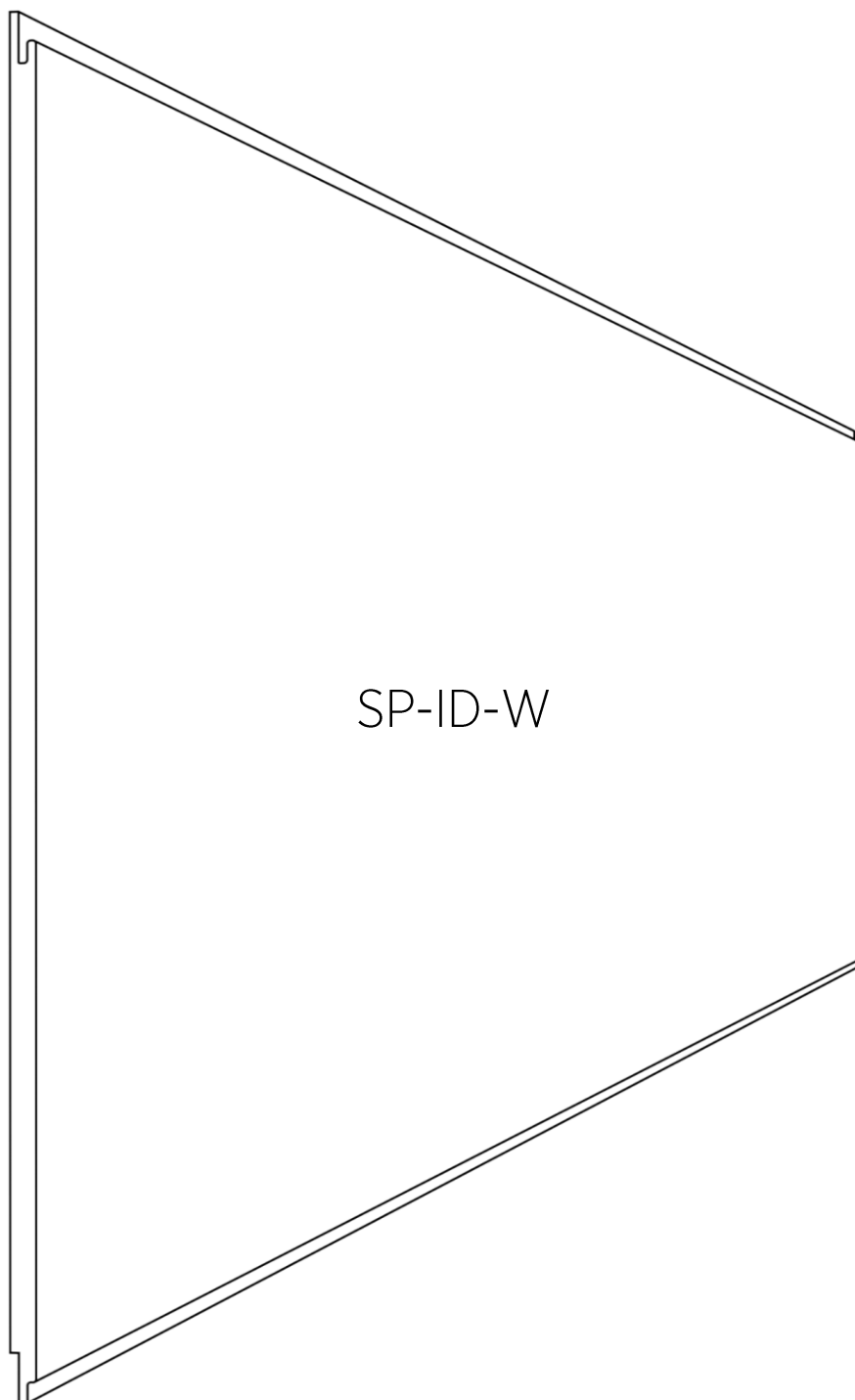

# STRAMA PANELS

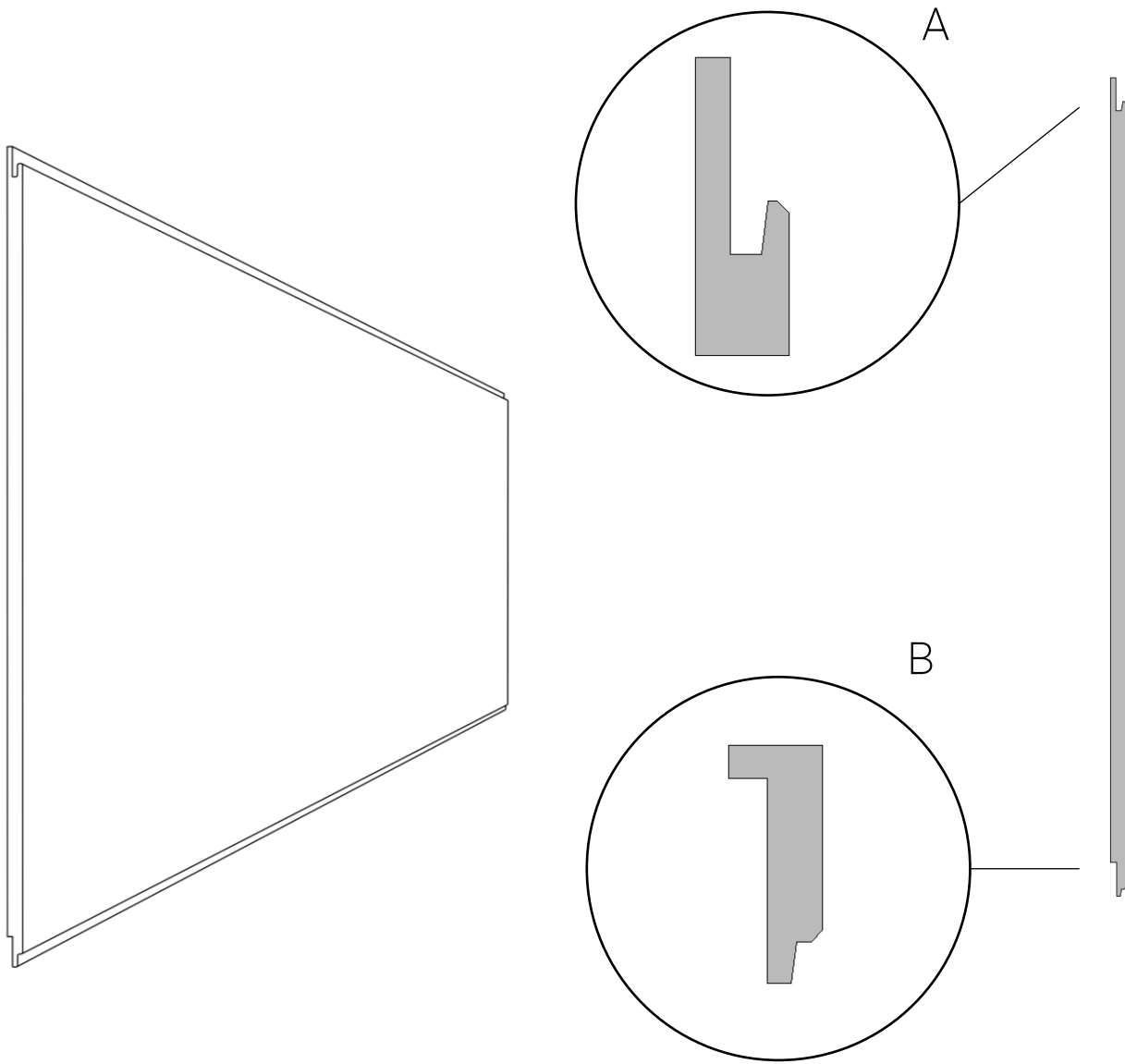

Instrukcja montażu / Manual  
STRAMA PANELS INTERIOR DESIGN - WALL



B

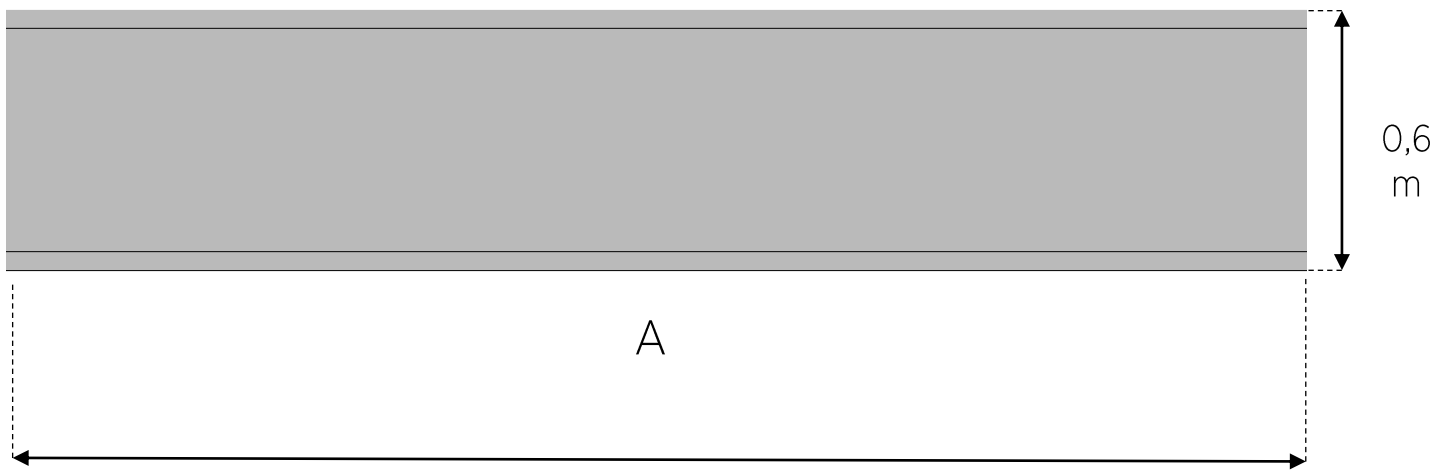

2,18 m / 2,8 m / \*

\* na zamówienie / on request

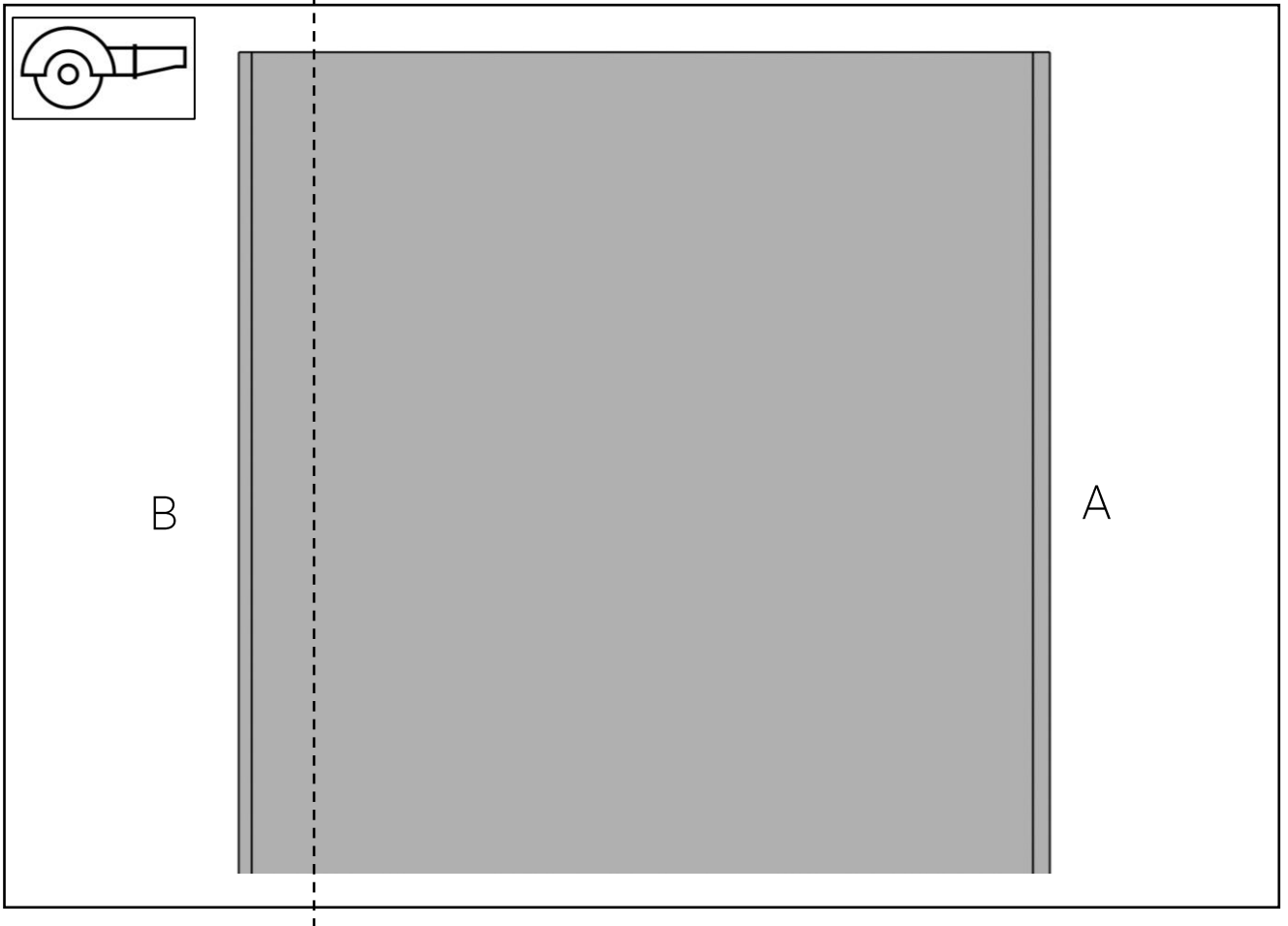
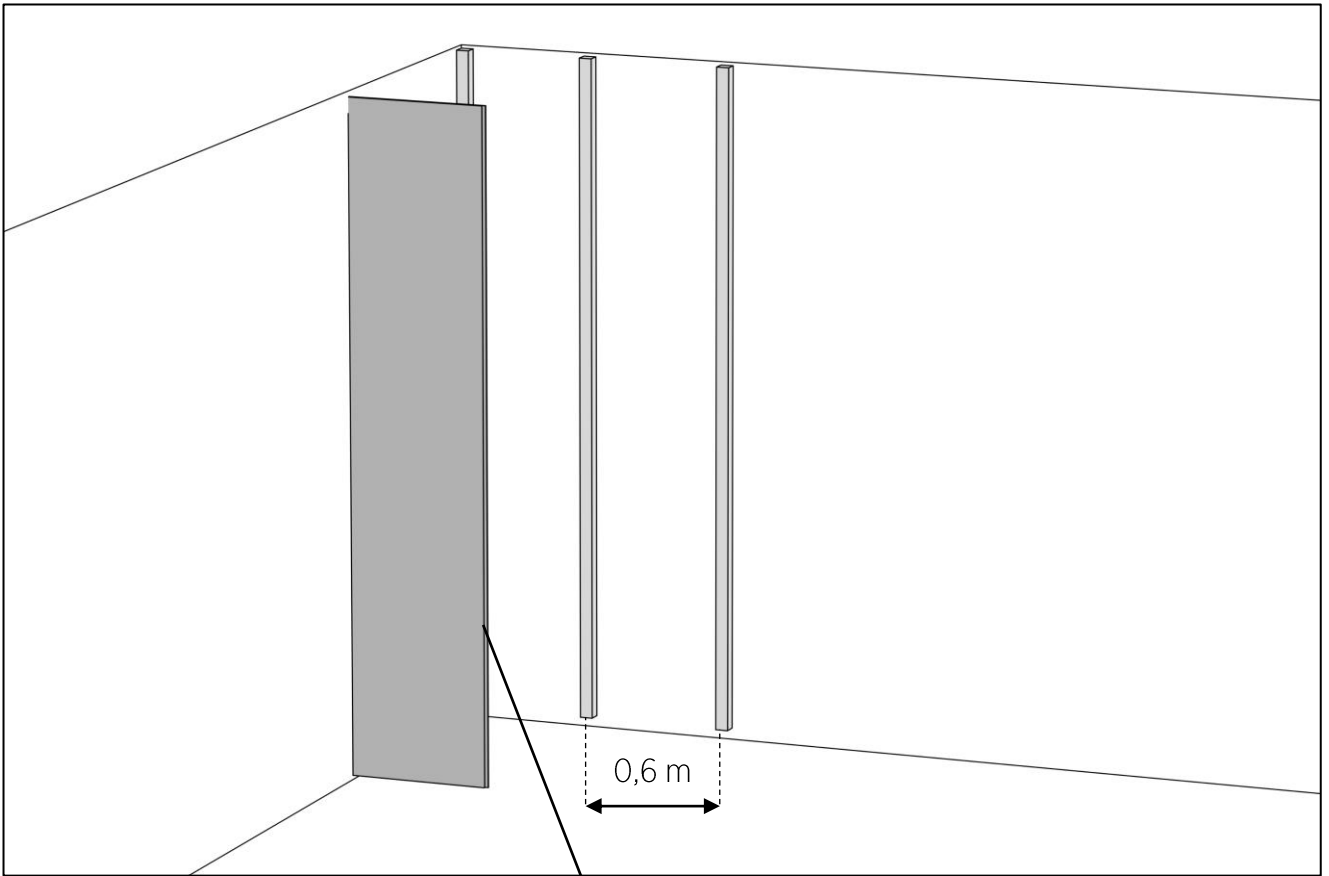

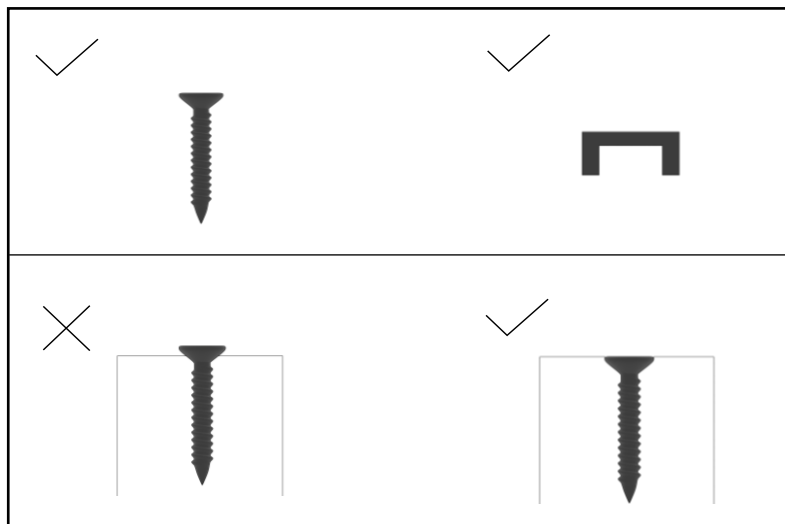
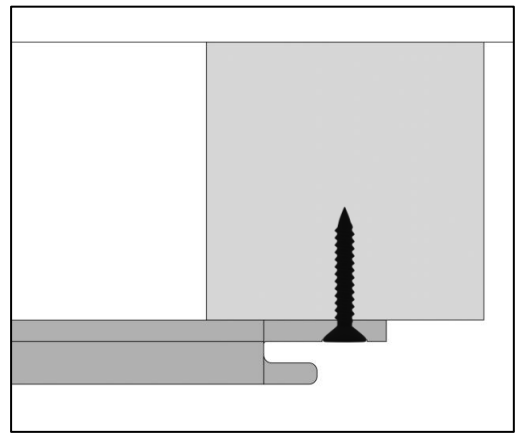
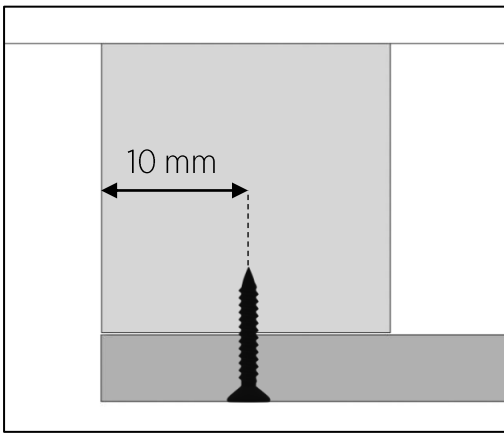
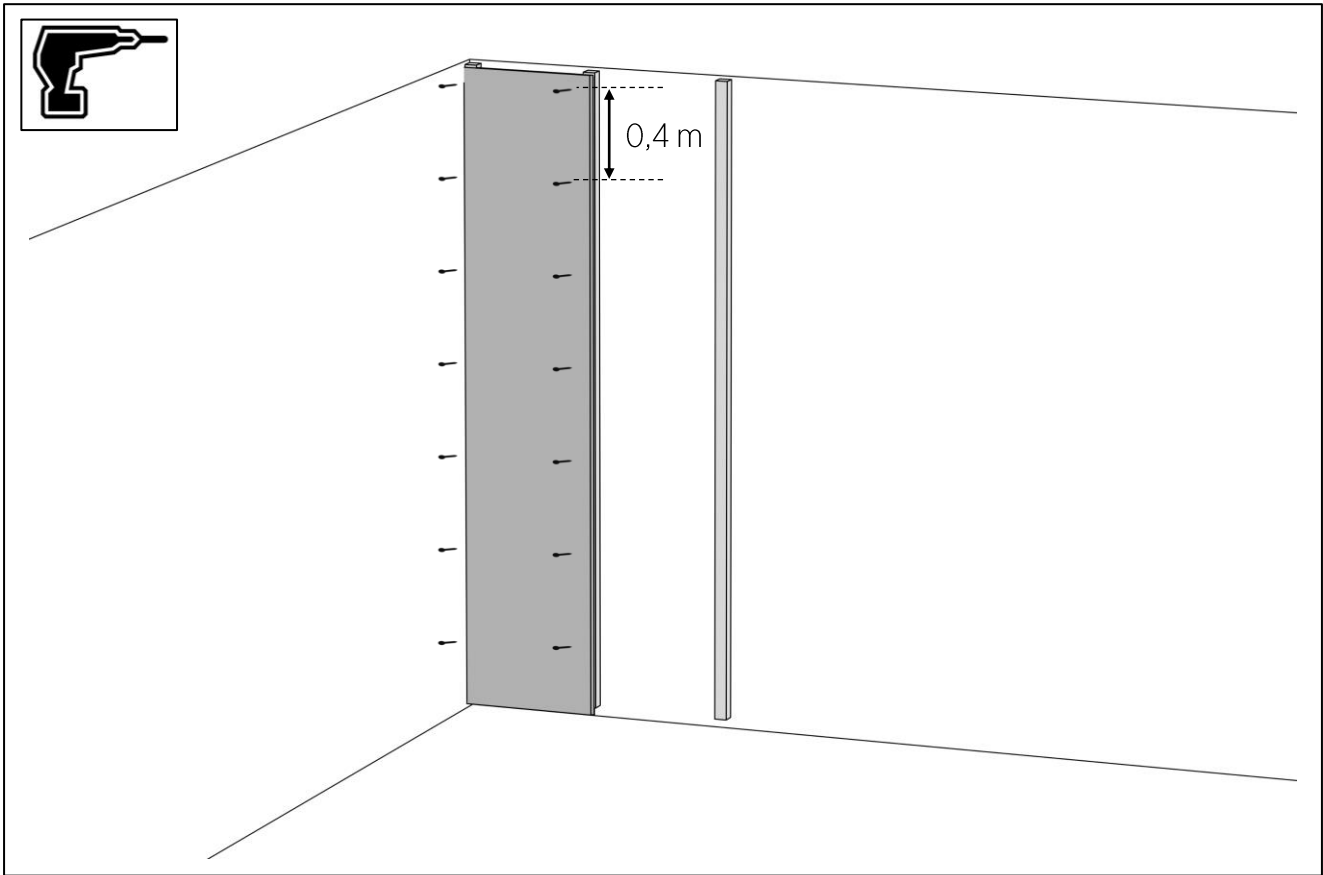

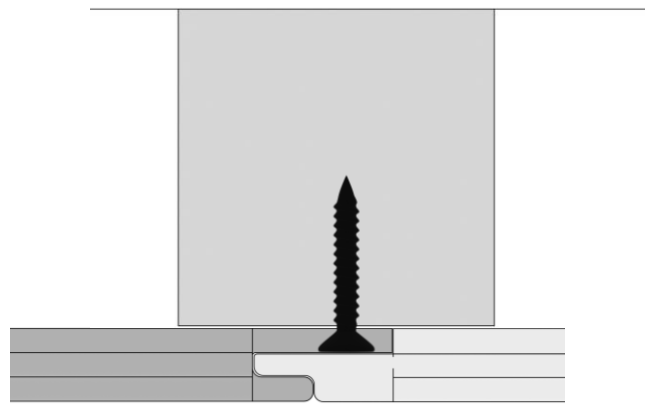
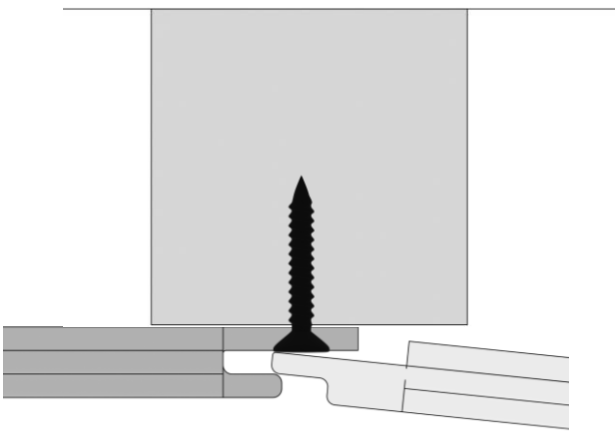
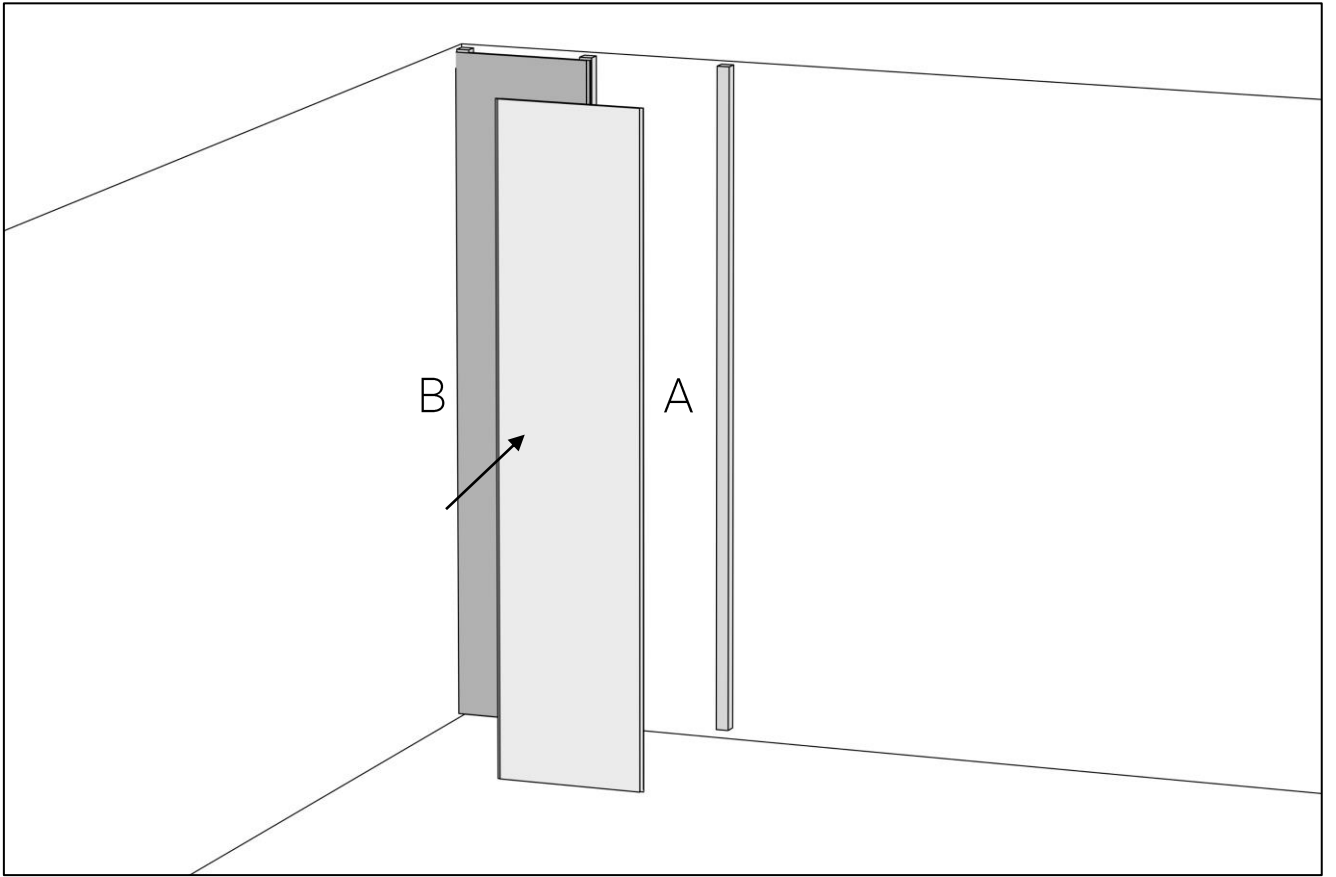

CLICK!

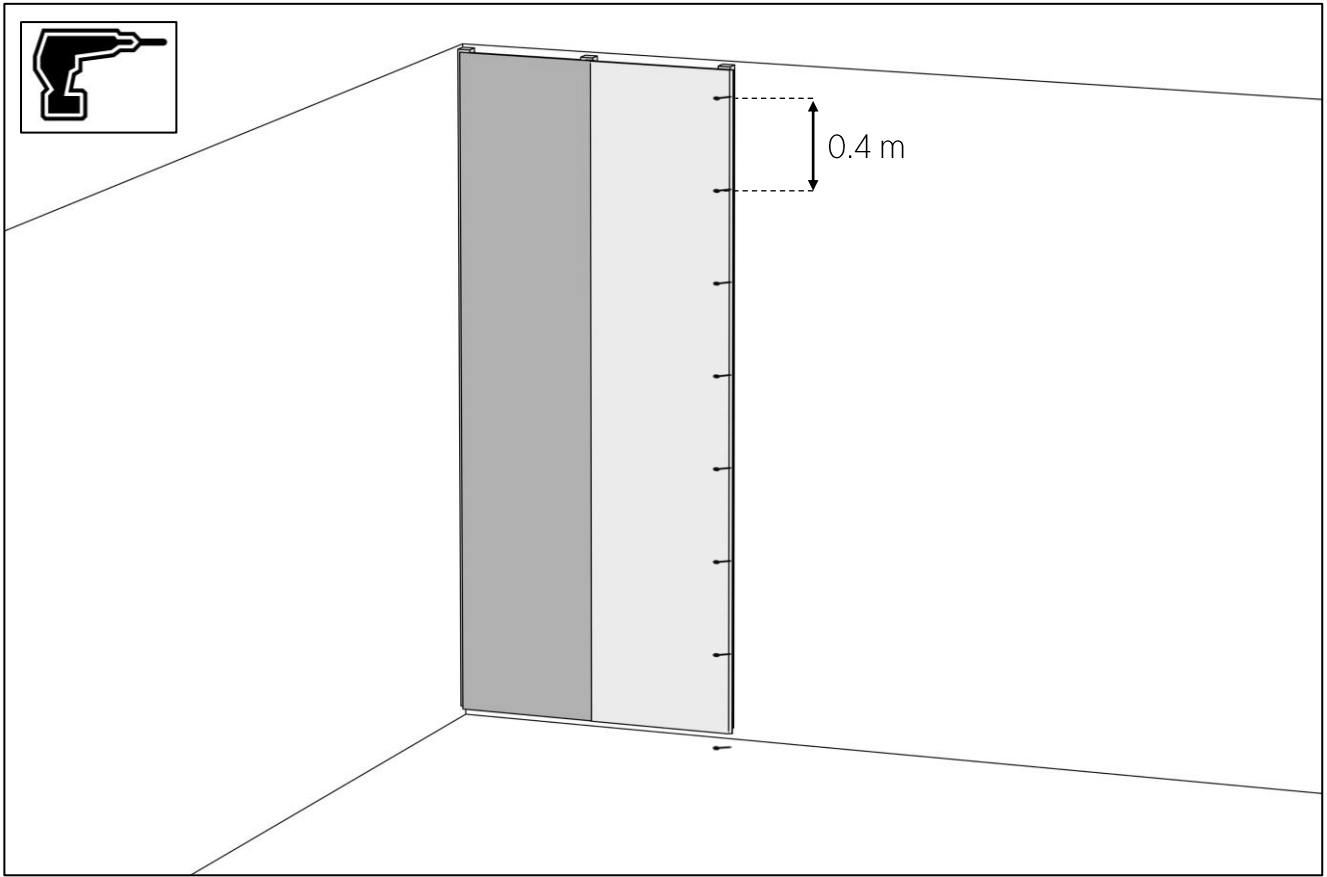

### DILATATION

